

Powered by



UXL12V100AH ▶ 12V100Ah

UXL系列采用阀控密封氧复合技术,特殊的耐腐蚀合金,高强度AGM隔板,高纯度材料使电池自放电小,寿命长.

UXL series uses valve control sealed oxygen composite technology, special corrosion resistant alloy, high strength AGM separator, high purity material to make the battery self-discharge is small, long service life.



目录Table of contents

额定电压 Rated Voltage	12
额定容量Nominal Capacity(C10@1.8V@25°C)	100Ah
重量Approx Weight	29.5kg ±3%(65.04lbs)
最大放电电流Max. Discharge Current	1000A(5S)
内阻Internal Resistance(25°C)	5.2mΩ
工作温度范围Operating Temp. Range	放电Discharge:-15°C~50°C(5°F~122°F) 充电Charge:-15°C~40°C(5°F~104°F) 储存Storage:-15°C~40°C(5°F~104°F)
推荐工作温度Nominal Operating Temp. Range	25°C±3°C(77°F±5°F)
最大充电电流Max.Charging Current(25°C)	30A
浮充电压Float voltage	13.5~13.8V@25°C(77°F)
均充电压Equalizing voltage	14.1~14.4V@25°C(77°F)
端子Terminal	M8
外壳材质Container Material	ABS(UL 94-V0)(UL 94-HB)



IT1548HL06061801



尺寸Dimension :	长Length	宽Width	高Container Height	总高Total Height
单位unit: mm	331±2.5	175±1.5	215±2.5	221±2.5

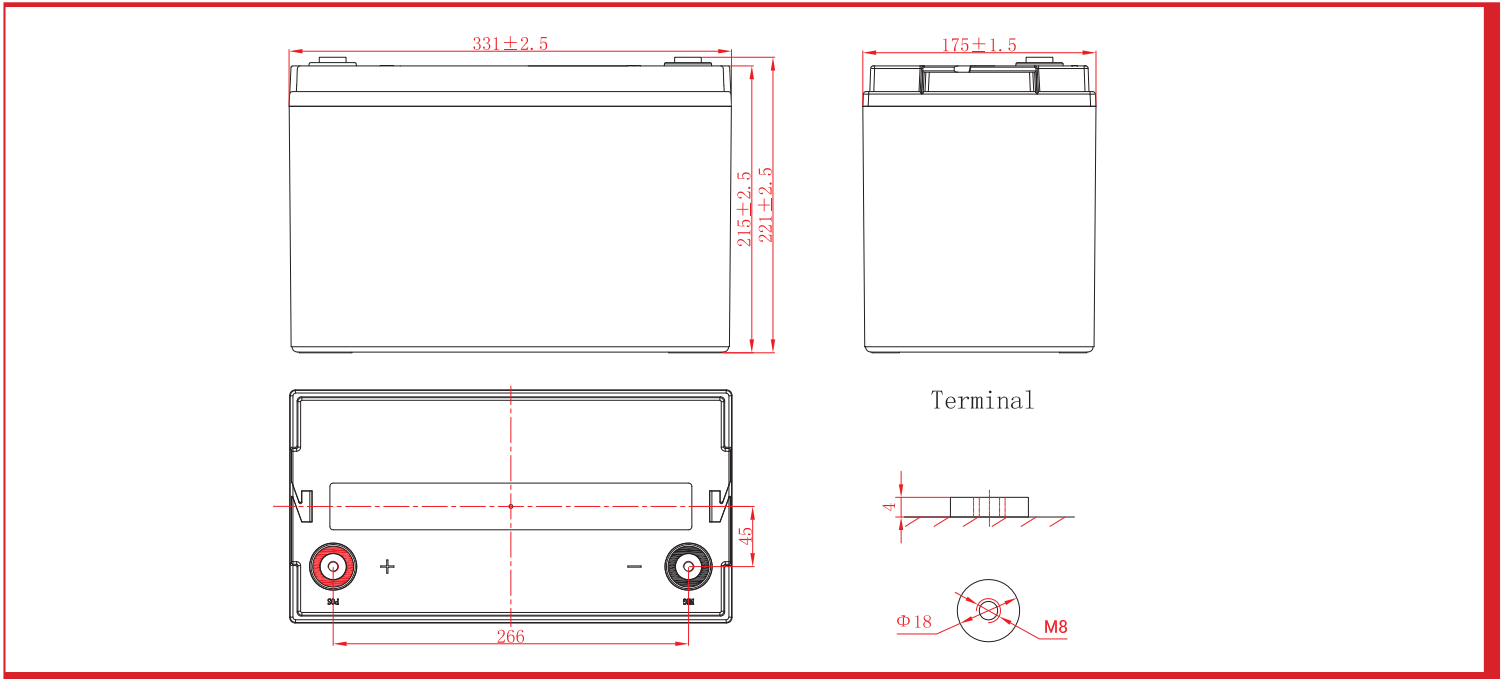

恒流放电表 Constant current discharge meter 单位 Unit: 安培 A(25°C/77°F)

F.V/Time	10min	15min	30min	1h	3h	5h	10h	20h
1.60V	225	169	106	63.7	26.8	17.9	10.3	5.47
1.67V	218	165	104	62.8	26.5	17.8	10.2	5.45
1.70V	214	162	102	62.1	26.4	17.7	10.2	5.43
1.75V	202	153	98.6	60.1	25.9	17.5	10.2	5.38
1.80V	184	142	93.9	57.5	24.9	17.0	10.0	5.30
1.85V	159	125	87.9	53.3	22.9	15.8	9.61	5.13

恒功率放电表 Constant power discharge meter 单位Unit: 瓦特/单格 W/cell(25°C/77°F)

F.V/Time	10min	15min	30min	1h	3h	5h	10h	20h
1.60V	399	322	200	121	52.8	35.0	20.2	10.8
1.67V	378	305	196	120	52.3	34.9	20.1	10.7
1.70V	362	292	194	119	51.9	34.8	20.1	10.7
1.75V	328	265	188	116	50.9	34.3	19.9	10.6
1.80V	287	234	179	112	49.1	33.4	19.7	10.4
1.85V	235	194	168	106	45.6	31.4	19.0	10.1

温度对浮充寿命的影响

Temperature Effects on Long Term Float Life

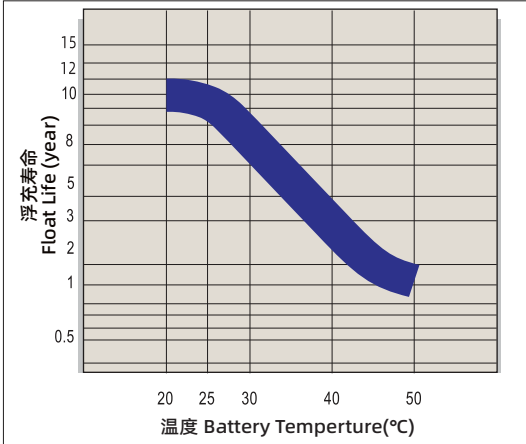

温度对容量的影响

The effect of temperature on capacity

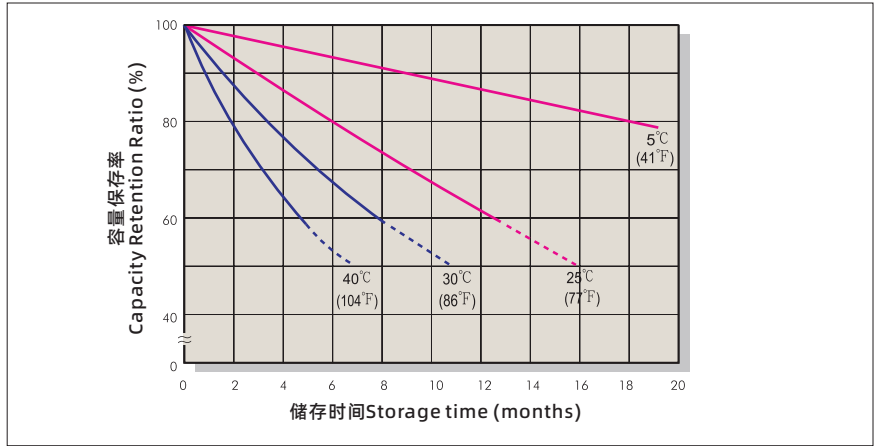

浮充特性曲线

Float Charging Characteristics

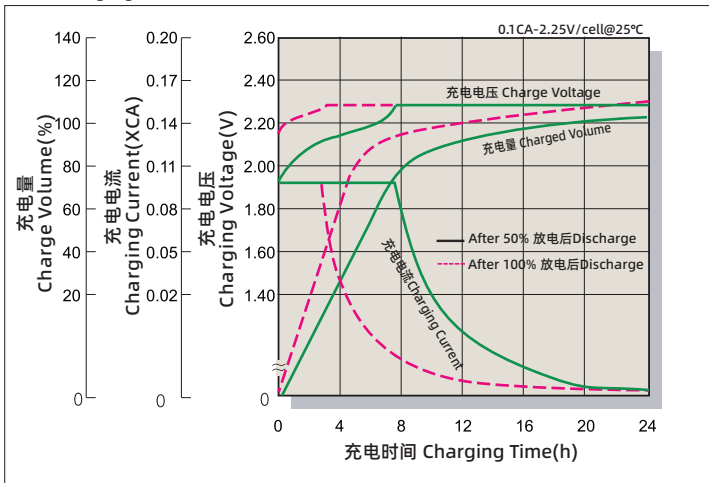

放电特性曲线

Discharge Characteristics

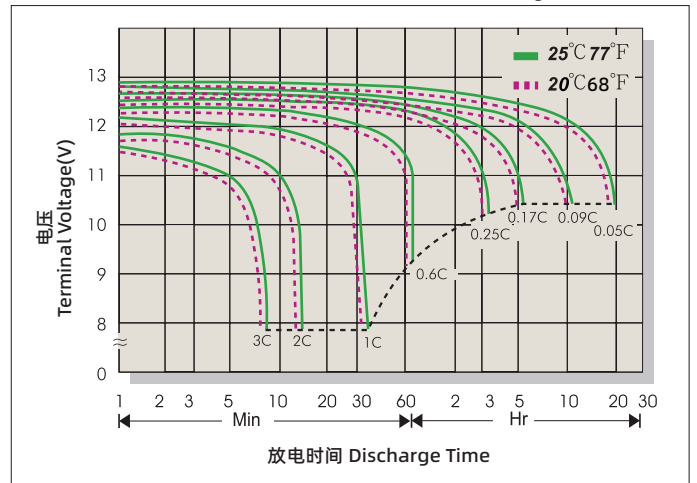

温度对容量的影响

The effect of temperature on capacity(10HR)

温度 Temperature	容量 Capacity(10HR)
40°C	103%
25°C	100%
0°C	85%
-15°C	65%

自放电特性

Self-discharge characteristics

存放时间 Storage time	剩余容量 The remaining capacity
3月 months	91%
6月 months	82%
12月 months	64%

应用 Applications

- 通讯 Telecommunications
- UPS、数据机房 UPS、Data Rooms
- 紧急照明、安防 Emergency Lighting、Security
- 储能、电力 Energy Storage、Electric Systems
- 新能源系统 New Energy Systems

Baace生产的电池阀控式铅酸蓄电池通过UL认证 (UL2000)

Baace-manufactured VRLA(Absorbent Glass Mat type)batteries are UL-recognized Components under UL1989.

Baace也通过了认证ISO 9001和ISO 14001。

Baace is also certified by ISO 9001 and ISO 14001.

江西恒力电池科技有限公司

JIANGXI HENGLI TECHNOLOGY BATTERY CO.,LTD.

地址:江西省抚州市抚北工业园广银大道